

**MEHRFAMILIENHAUS  
ZILMATTSTRASSE 105  
3255 RAPPERSWIL (BE)  
4.5 ZIMMER**

**WOHNUNG:** WHG-105-00.10, EG  
**KELLER:** 13.5 m<sup>2</sup>  
**SITZPLATZ:** 16.5 m<sup>2</sup>  
**NETTOWOHNFLÄCHE:** 119.0 m<sup>2</sup>

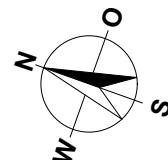

MASSTAB 1:100

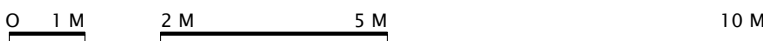
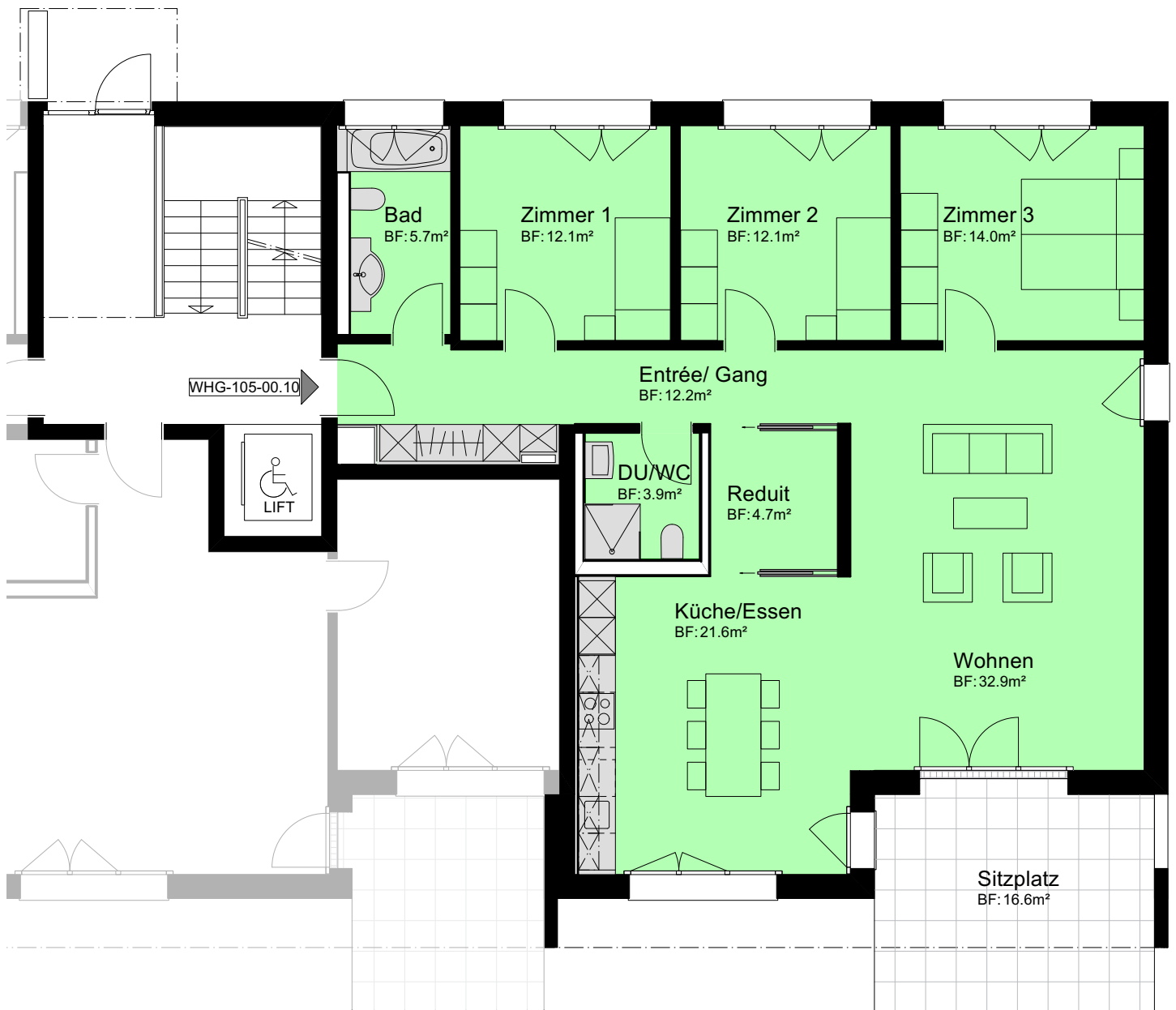
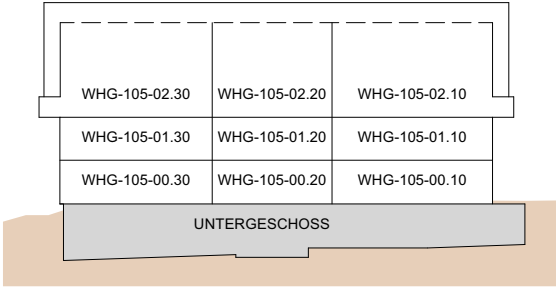

MEHRFAMILIENHAUS  
ZILMATTSTRASSE 105  
3255 RAPPERSWIL (BE)

HAUS 105  
UNTERGESCHOSS

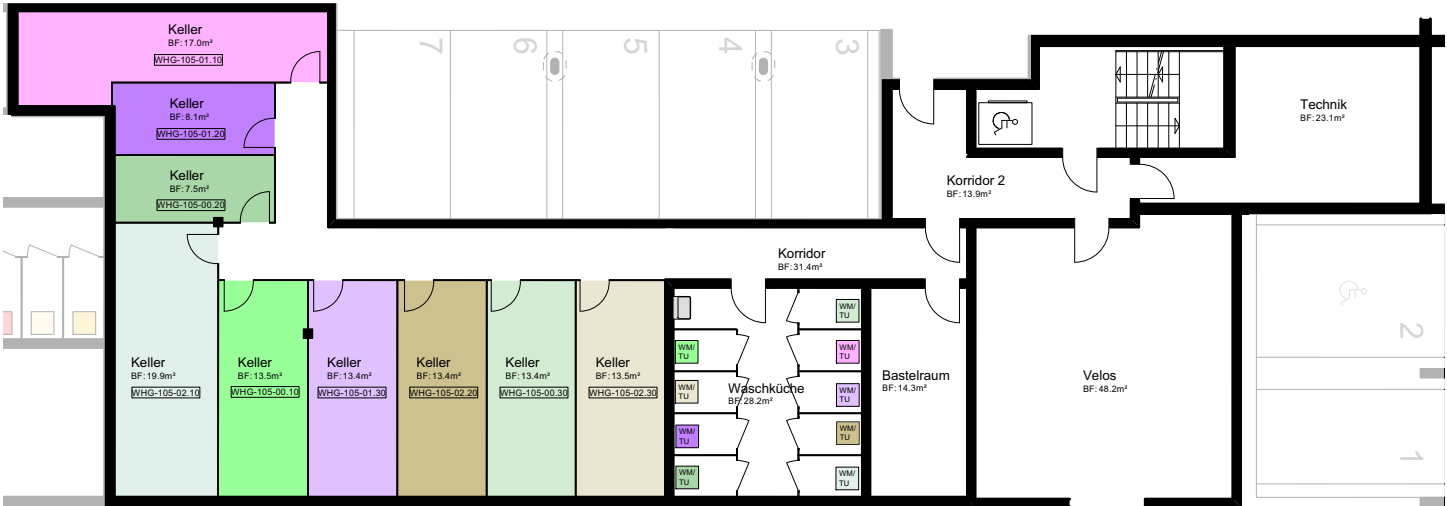

0 1 M 2 M 5 M 10 M

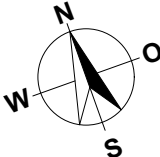

MASSTAB 1:200

MEHRFAMILIENHAUS  
ZILMATTSTRASSE 105  
3255 RAPPERSWIL (BE)

HAUS 105  
SCHNITTE

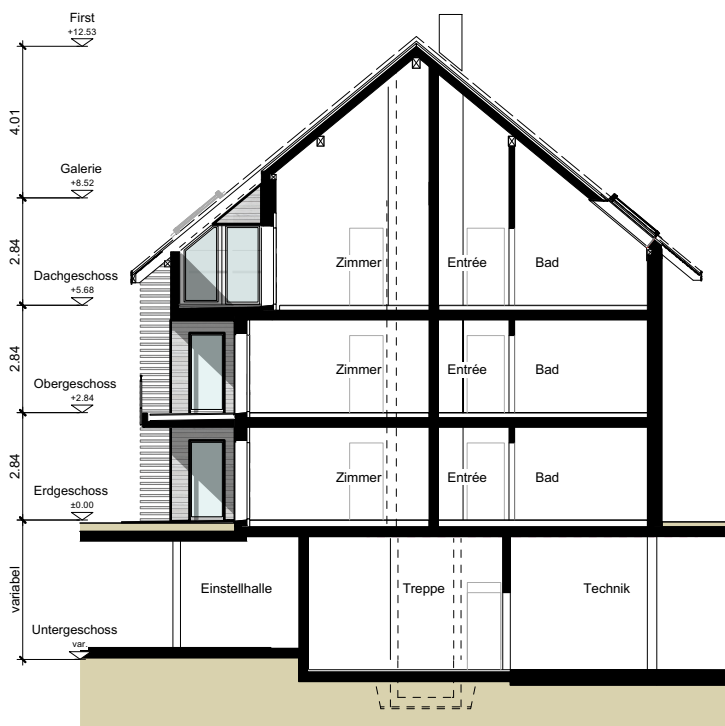
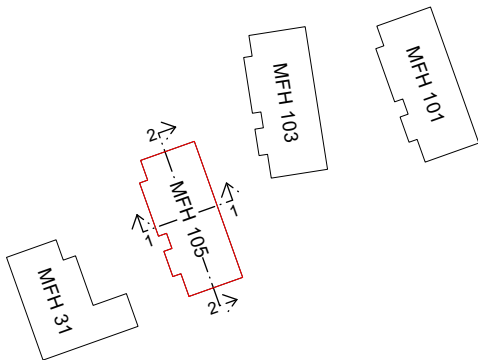

SCHNITT 1-1

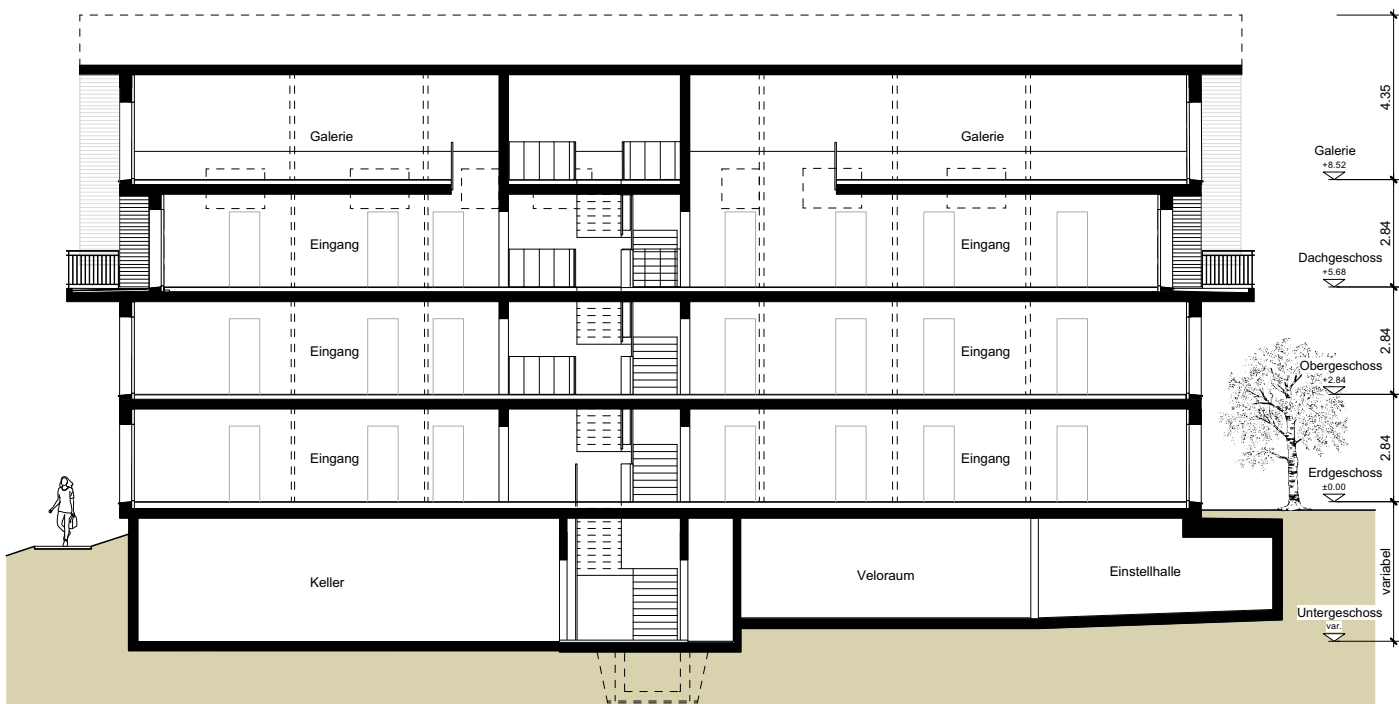

SCHNITT 2-2

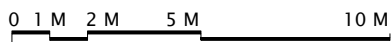

MASSTAB 1:200

MEHRFAMILIENHAUS  
ZILMATTSTRASSE 105  
3255 RAPPERSWIL (BE)

HAUS 105  
FASSADEN

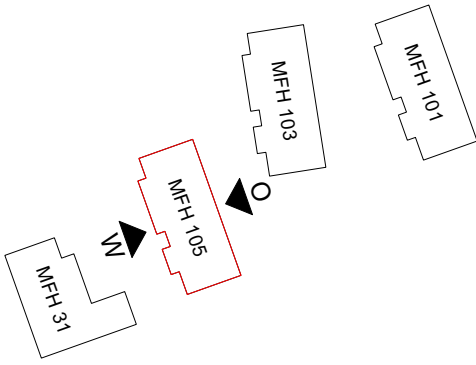

OSTEN



WESTEN

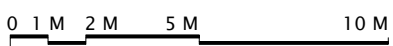

MASSTAB 1:200

MEHRFAMILIENHAUS  
ZILMATTSTRASSE 105  
3255 RAPPERSWIL (BE)

HAUS 105  
FASSADEN

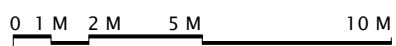
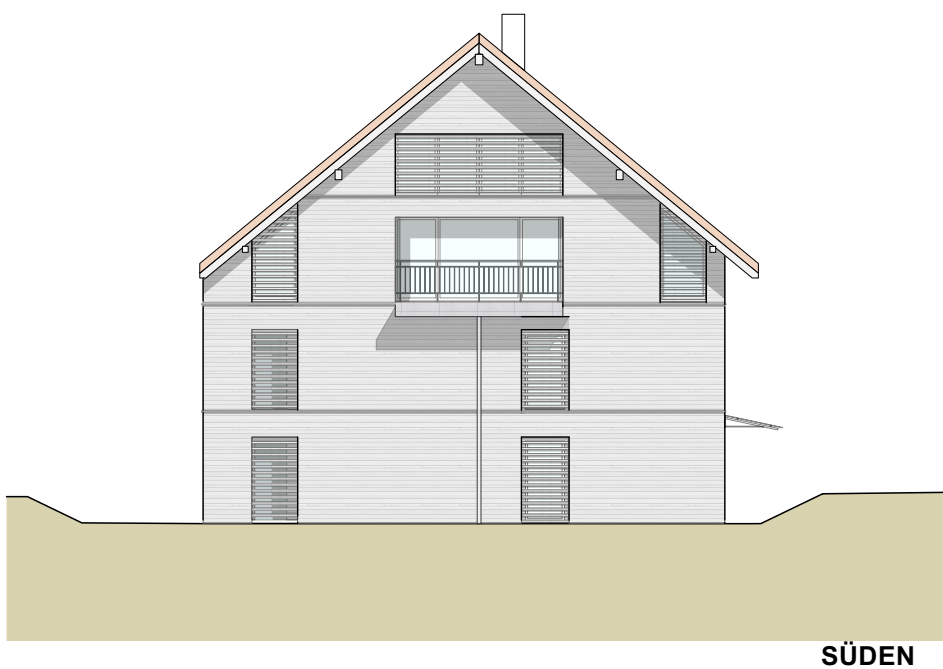
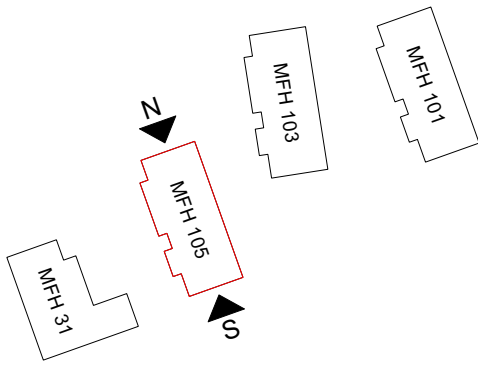

MASSTAB 1:200

MEHRFAMILIENHÄUSER  
HAUPTSTRASSE 31  
ZILMATTSTRASSE 101, 103 UND 105  
3255 RAPPERSWIL (BE)

SITUATION / UNTERGESCHOSS / ESTH

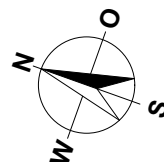
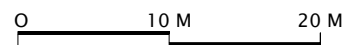
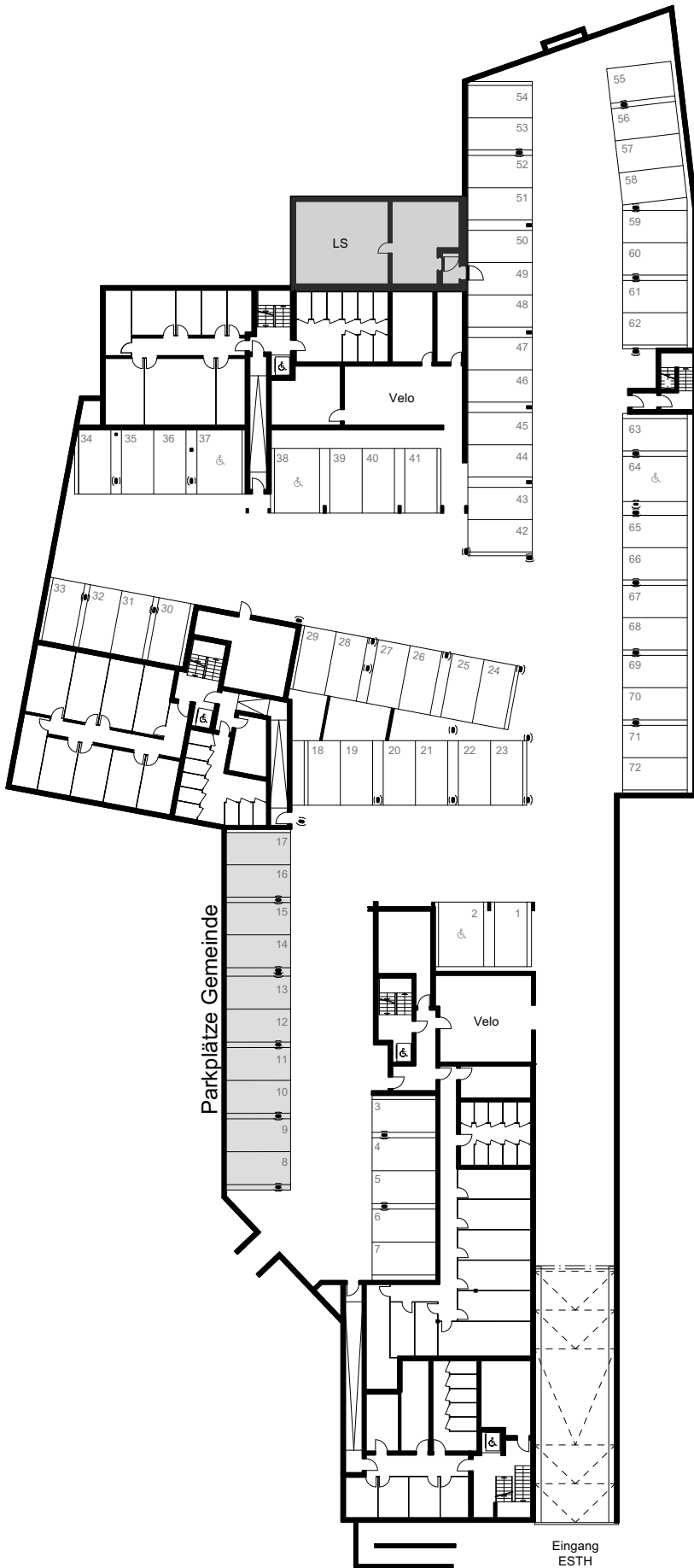

MASSSTAB 1:500