

MEHRFAMILIENHAUS  
 ZILMATTSTRASSE 103  
 3255 RAPPERSWIL (BE)  
 2.5 ZIMMER

WOHNUNG: WHG-103-01.20, OG  
 KELLER: 11.0 m<sup>2</sup>  
 BALKON: 11.0 m<sup>2</sup>  
 NETTOWOHNFLÄCHE: 53.5 m<sup>2</sup>

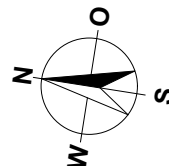

MASSTAB 1:100

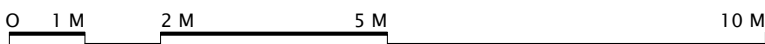
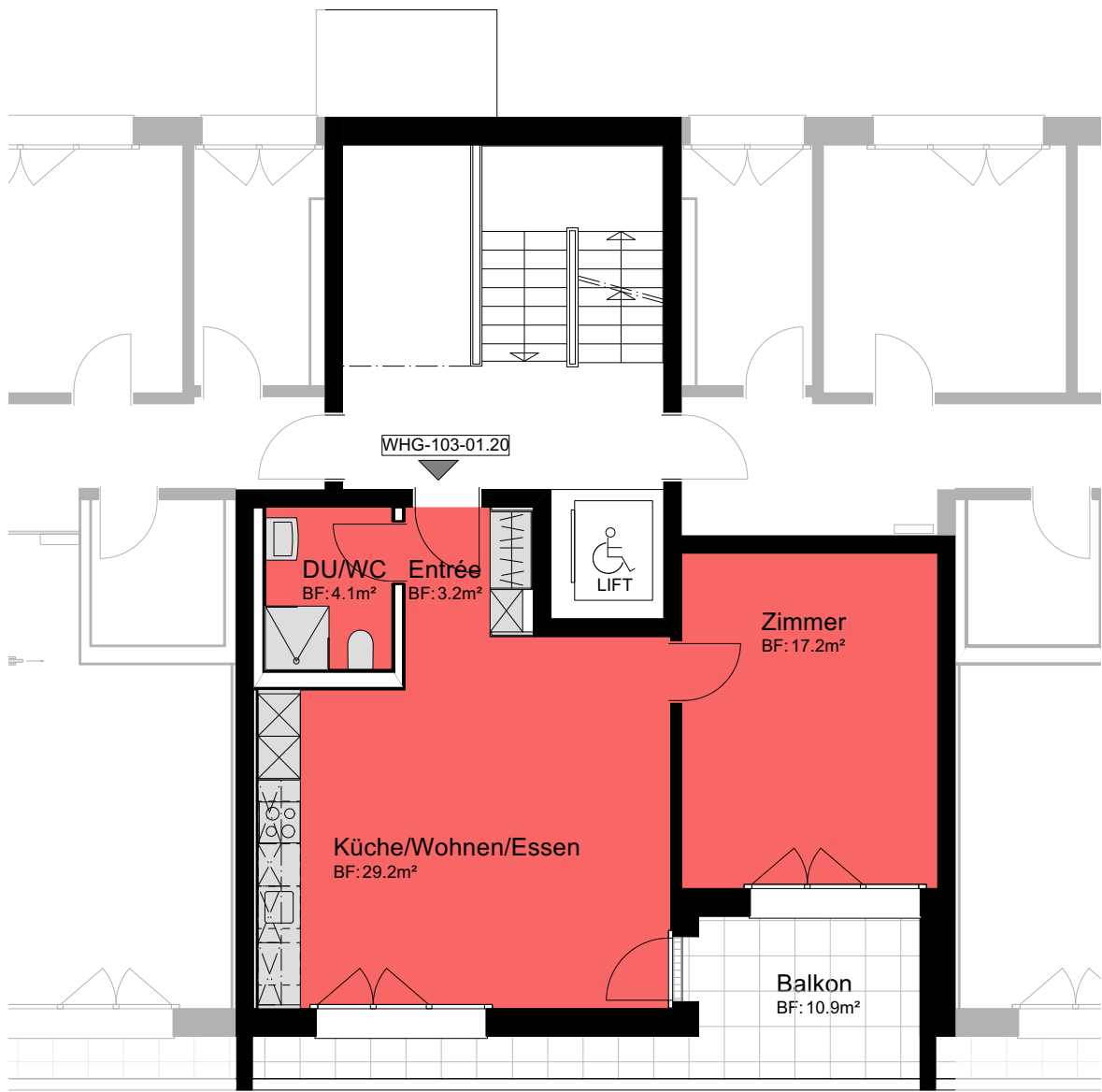
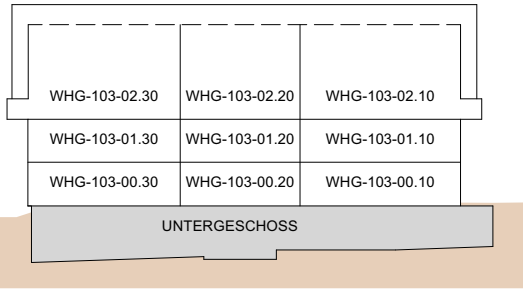

MEHRFAMILIENHAUS  
ZILMATTSTRASSE 103  
3255 RAPPERSWIL (BE)

HAUS 103  
UNTERGESCHOSS

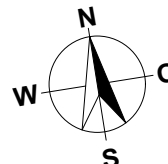

MASSTAB 1:150

MEHRFAMILIENHAUS  
ZILMATTSTRASSE 103  
3255 RAPPERSWIL (BE)

HAUS 103  
SCHNITTE

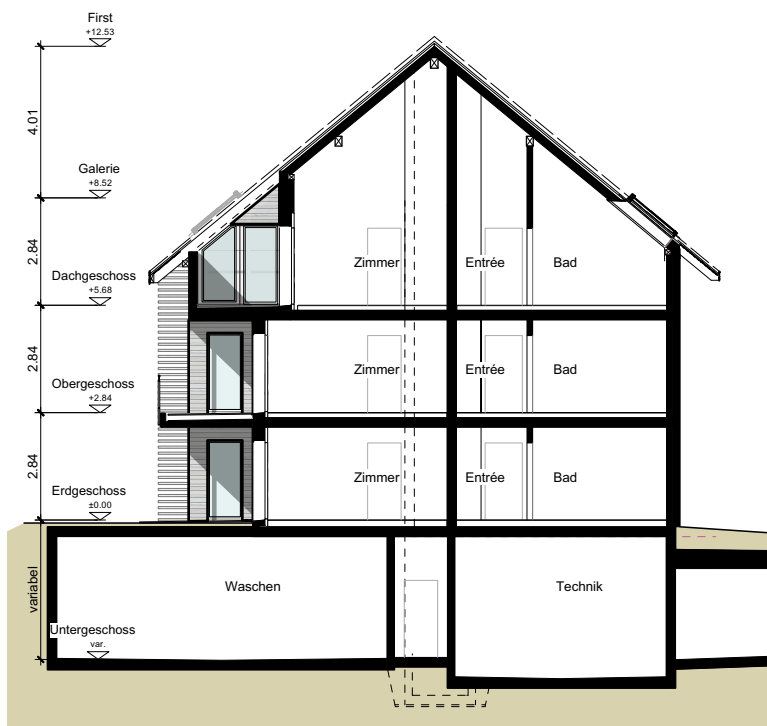
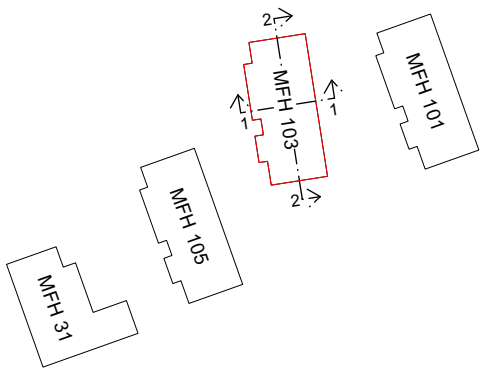

SCHNITT 1-1

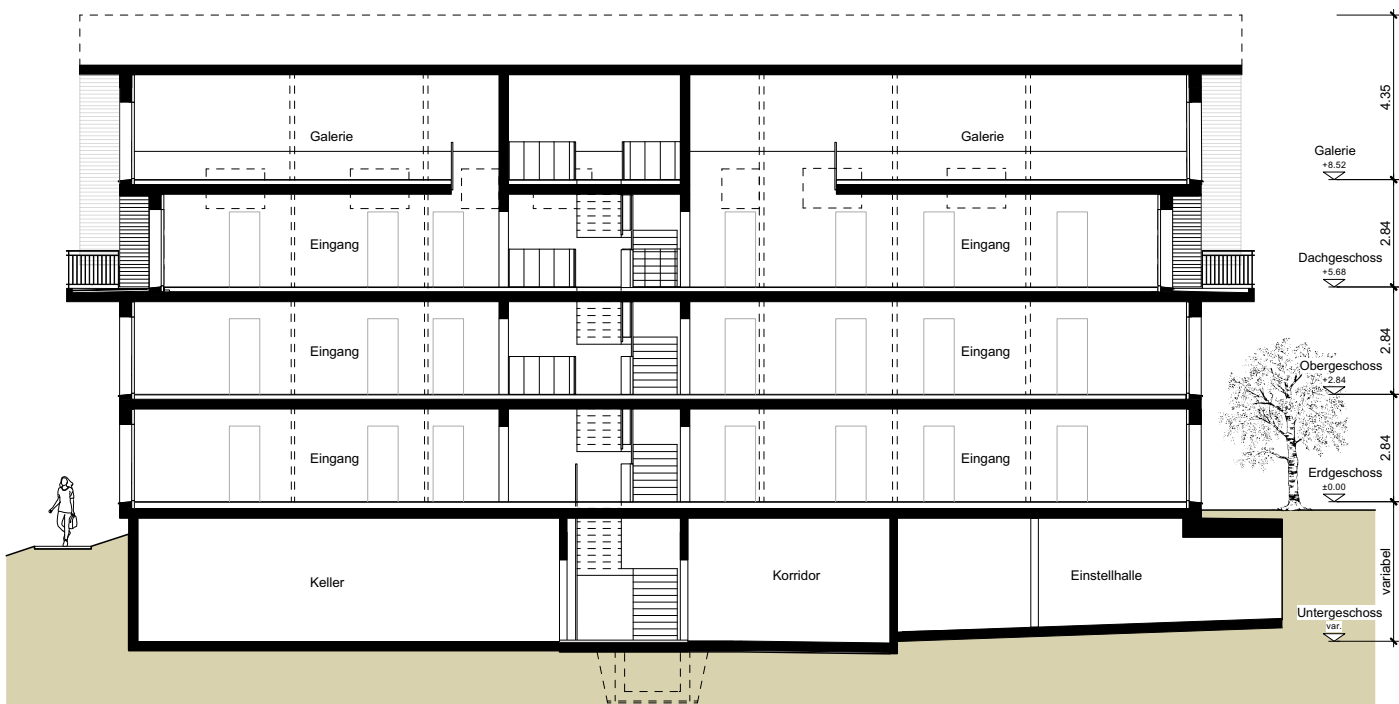

SCHNITT 2-2

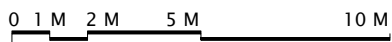

MASSTAB 1:200

MEHRFAMILIENHAUS  
ZILMATTSTRASSE 103  
3255 RAPPERSWIL (BE)

HAUS 103  
FASSADEN

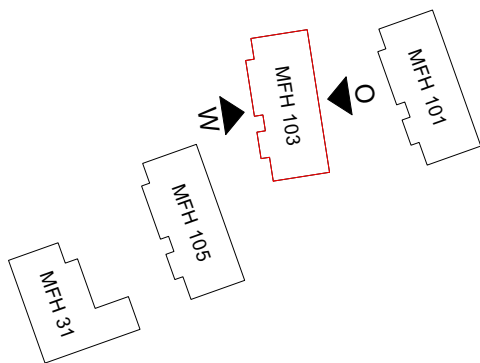

OSTEN



WESTEN

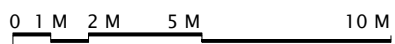

MASSTAB 1:200

MEHRFAMILIENHAUS  
ZILMATTSTRASSE 103  
3255 RAPPERSWIL (BE)

HAUS 103  
FASSADEN

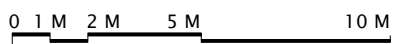
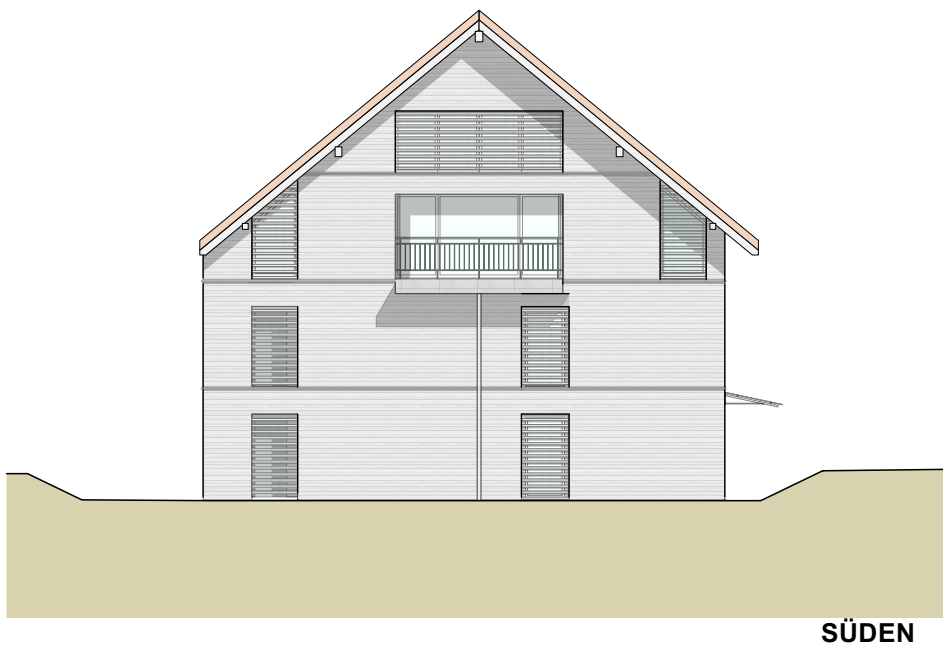
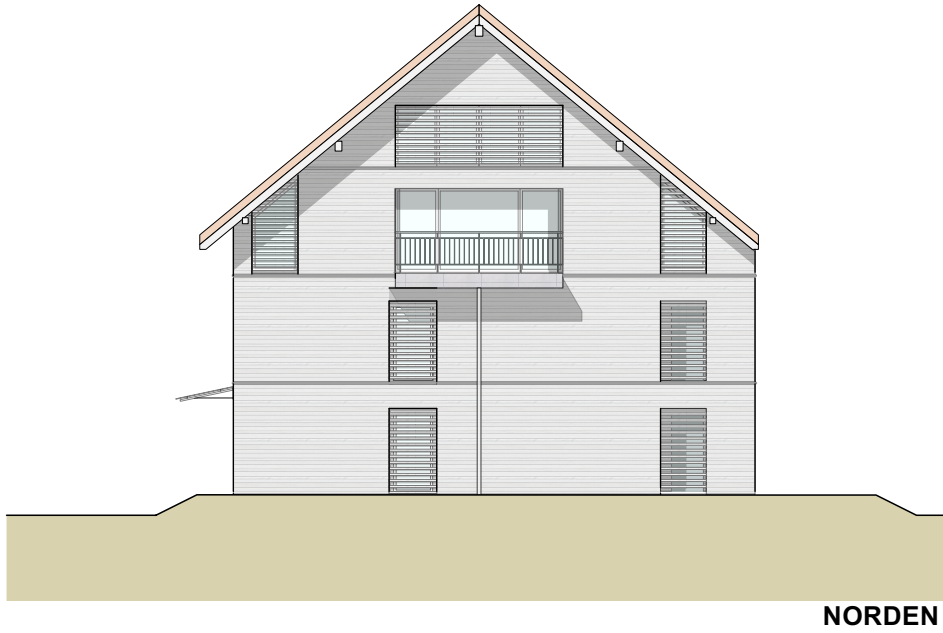
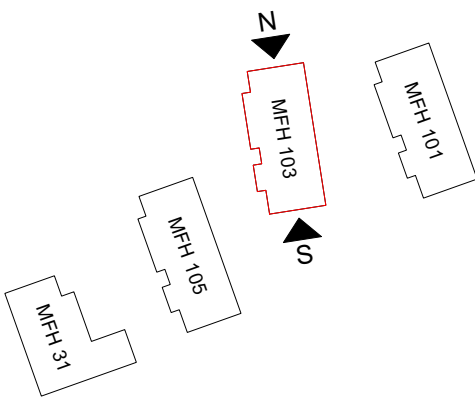

MASSTAB 1:200

MEHRFAMILIENHÄUSER  
HAUPTSTRASSE 31  
ZILMATTSTRASSE 101, 103 UND 105  
3255 RAPPERSWIL (BE)

SITUATION / UNTERGESCHOSS / ESTH

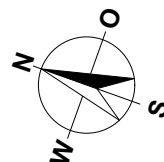
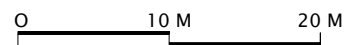

MASSSTAB 1:500