

MEHRFAMILIENHAUS
 ZILMATTSTRASSE 103
 3255 RAPPERSWIL (BE)
 3.5 ZIMMER

WOHNUNG: WHG-103-01.30, OG
 KELLER: 12.0 m²
 BALKON: 12.0 m²
 NETTOWOHNFLÄCHE: 96.0 m²

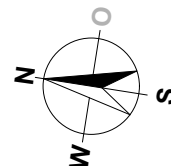
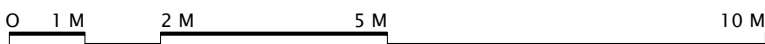
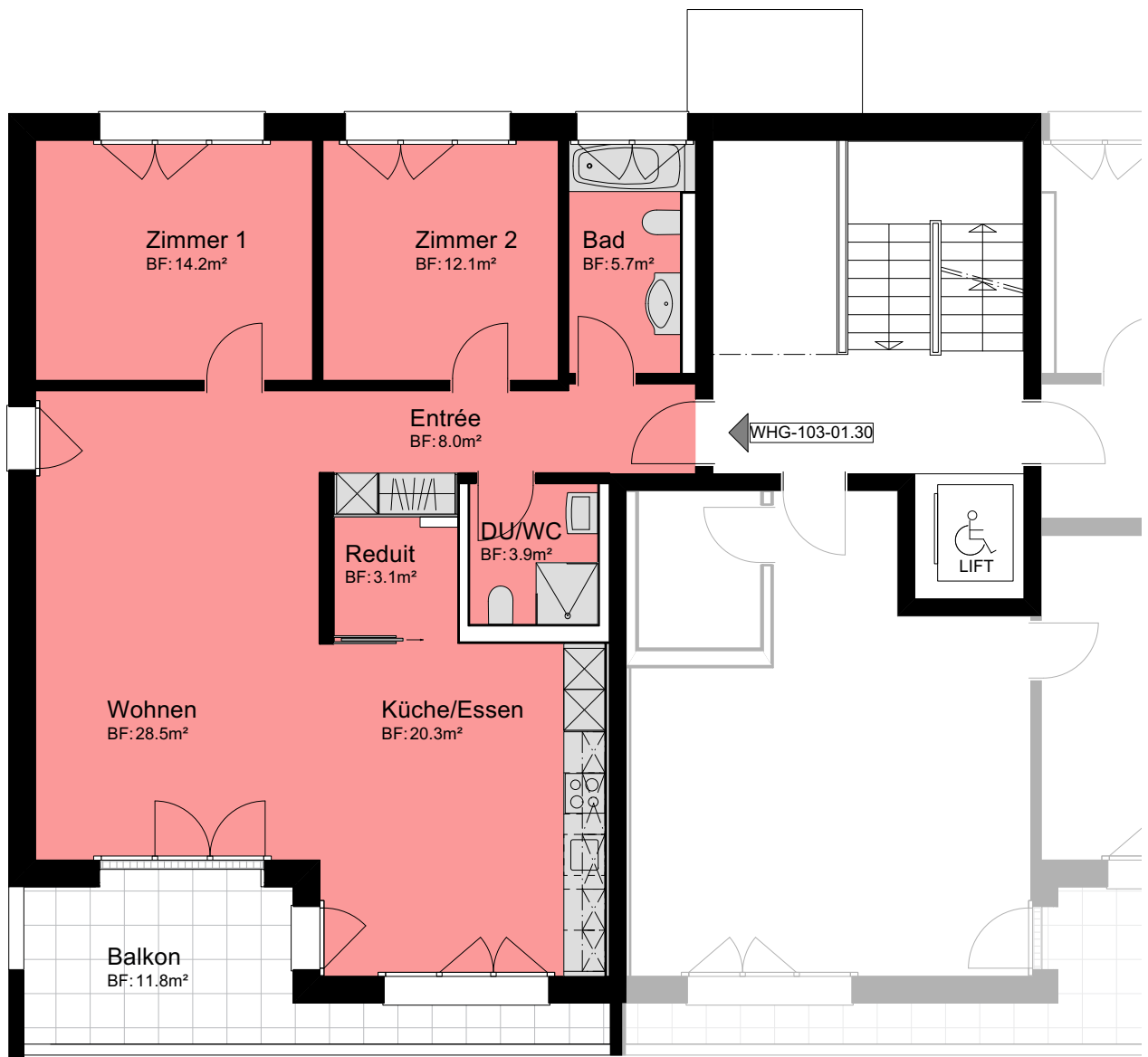

MASSTAB 1:100

WHG-103-02.30	WHG-103-02.20	WHG-103-02.10
WHG-103-01.30	WHG-103-01.20	WHG-103-01.10
WHG-103-00.30	WHG-103-00.20	WHG-103-00.10
UNTERGESCHOSS		

MEHRFAMILIENHAUS
ZILMATTSTRASSE 103
3255 RAPPERSWIL (BE)

HAUS 103
UNTERGESCHOSS

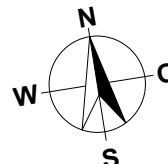

MASSTAB 1:150

MEHRFAMILIENHAUS
ZILMATTSTRASSE 103
3255 RAPPERSWIL (BE)

HAUS 103
SCHNITTE

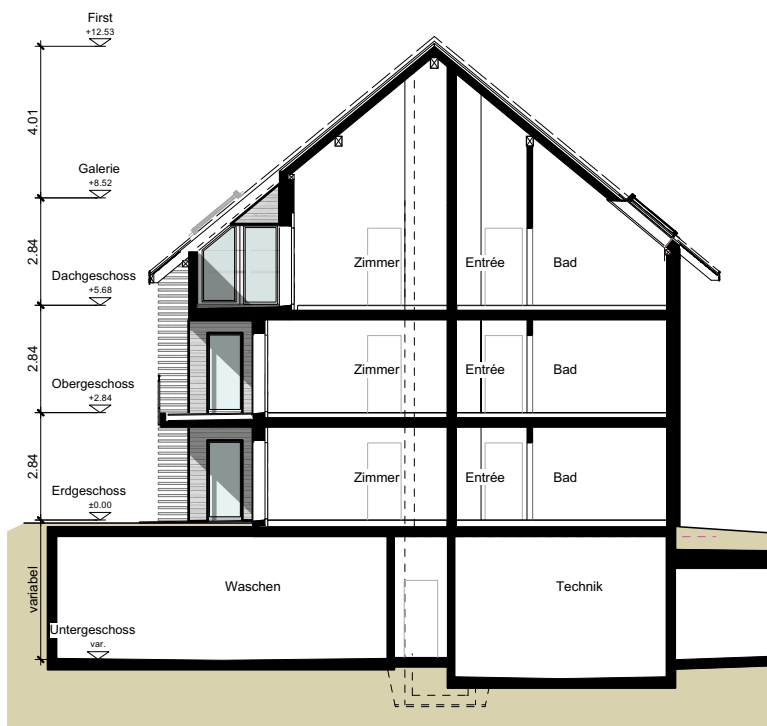
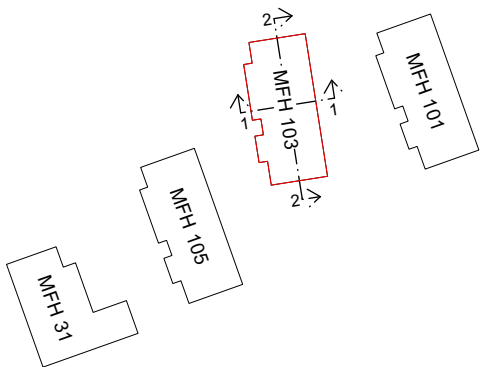

SCHNITT 1-1

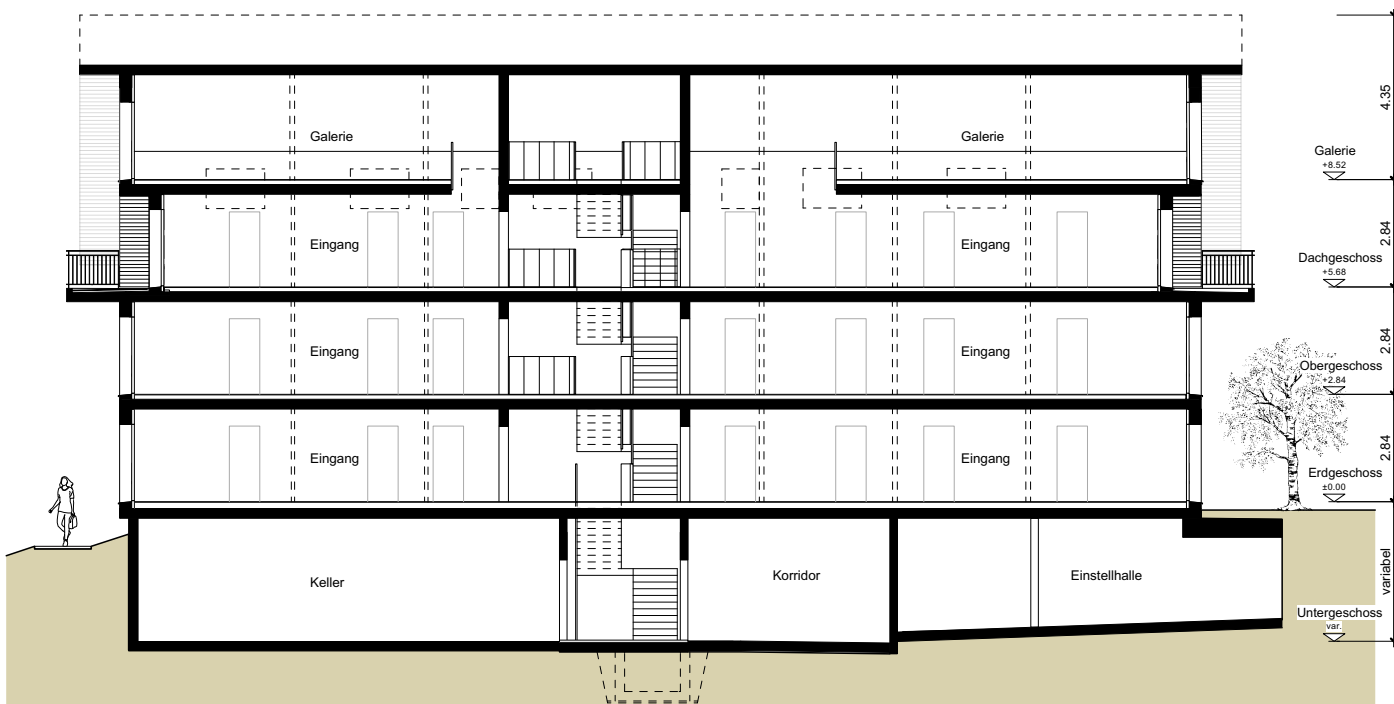

SCHNITT 2-2

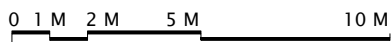

MASSTAB 1:200

MEHRFAMILIENHAUS
ZILMATTSTRASSE 103
3255 RAPPERSWIL (BE)

HAUS 103
FASSADEN

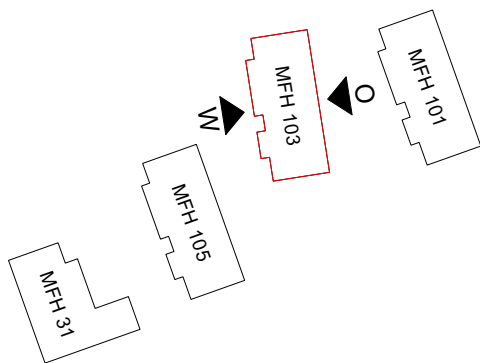

OSTEN



WESTEN

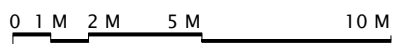

MASSTAB 1:200

MEHRFAMILIENHAUS
ZILMATTSTRASSE 103
3255 RAPPERSWIL (BE)

HAUS 103
FASSADEN

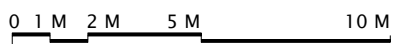
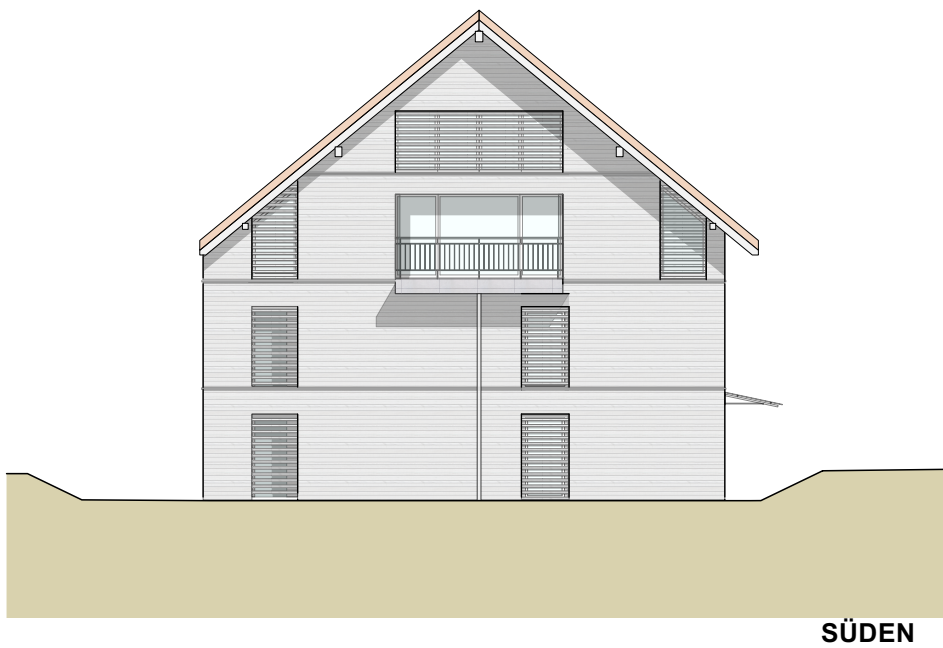
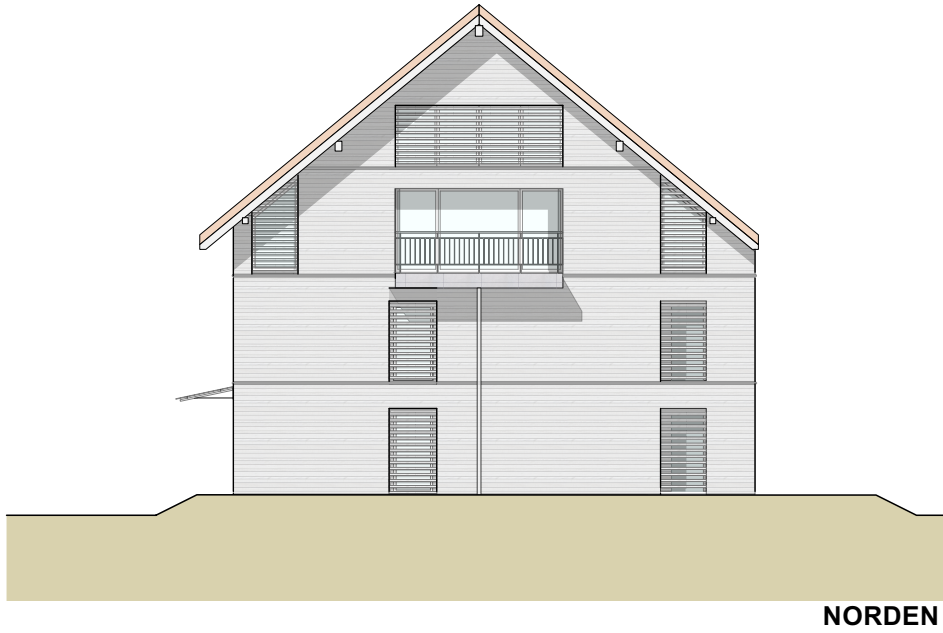
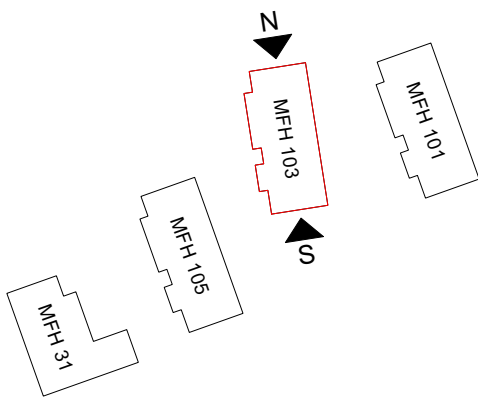

MASSTAB 1:200

MEHRFAMILIENHÄUSER
HAUPTSTRASSE 31
ZILMATTSTRASSE 101, 103 UND 105
3255 RAPPERSWIL (BE)

SITUATION / UNTERGESCHOSS / ESTH

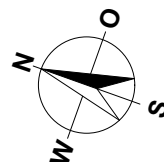
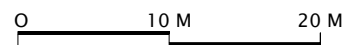
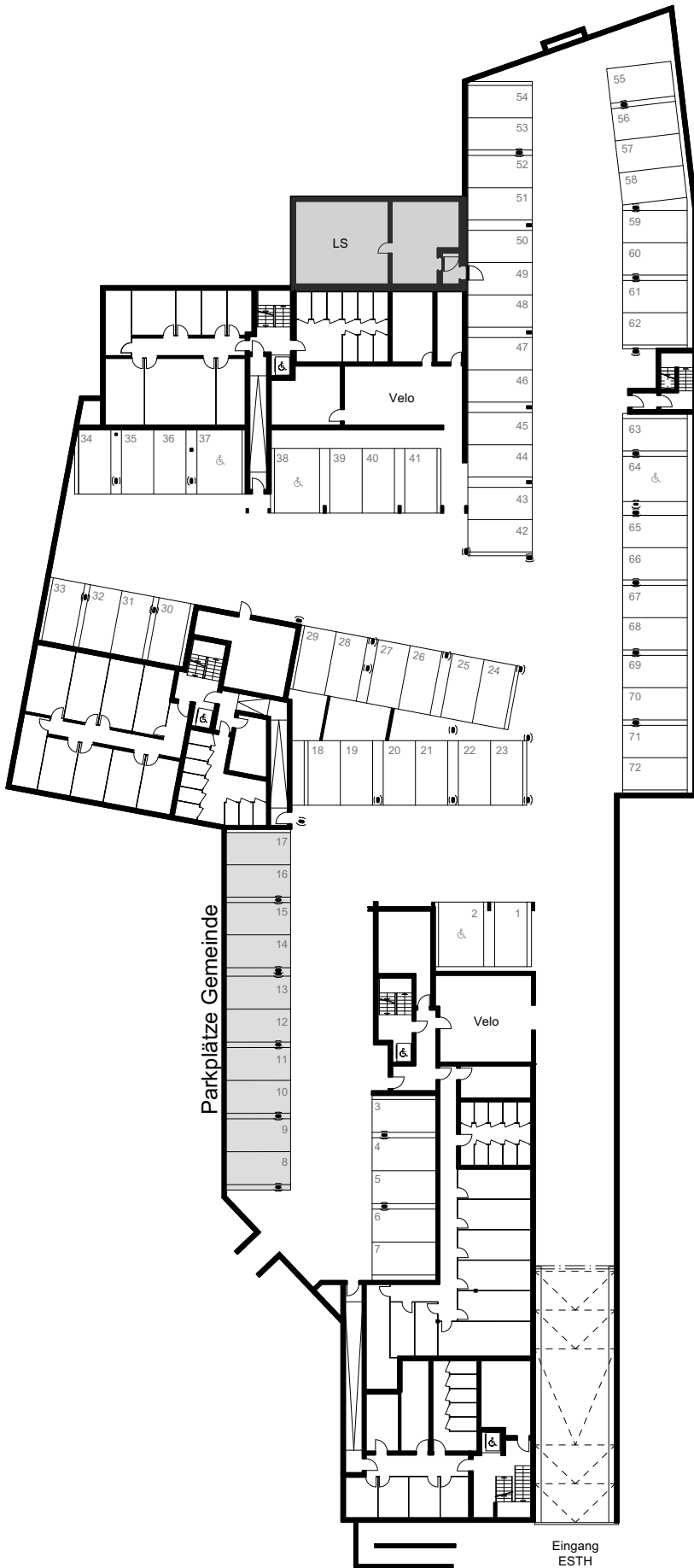

MASSSTAB 1:500